

Power supply unit - QUINT4-PS/3AC/24DC/5 - 2904620

Please be informed that the data shown in this PDF Document is generated from our Online Catalog. Please find the complete data in the user's documentation. Our General Terms of Use for Downloads are valid (<http://phoenixcontact.com/download>)

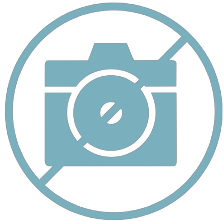

Primary-switched QUINT POWER power supply with free choice of output characteristic curve, SFB (selective fuse breaking) technology, and NFC interface, input: 3-phase, output: 24 V DC/5 A

Product Description

The fourth generation of the high-performance QUINT POWER power supplies ensures superior system availability by means of new functions. Signaling thresholds and characteristic curves can be individually adjusted via the NFC interface. The unique SFB technology and preventive function monitoring of the QUINT POWER power supply increase the availability of your application.

Your advantages

- SFB technology trips standard circuit breakers selectively, loads that are connected in parallel continue working
- Preventive function monitoring indicates critical operating states before errors occur
- Signaling thresholds and characteristic curves that can be adjusted via NFC maximize system availability
- Easy system extension thanks to static boost; starting of difficult loads thanks to dynamic boost
- High degree of immunity, thanks to integrated gas-filled surge arrester and mains failure bridging time of more than 20 milliseconds
- Robust design thanks to metal housing and wide temperature range from -40°C to +70°C
- Worldwide use thanks to the wide range input and international approval package



Key Commercial Data

Packing unit	1 pc
GTIN	 4 046356 985369
GTIN	4046356985369
Weight per Piece (excluding packing)	850.000 g
Weight per piece (including packing)	853.100 g
Custom tariff number	85044030
Country of origin	Thailand

Technical data

Dimensions

Width	36 mm
Height	130 mm

Power supply unit - QUINT4-PS/3AC/24DC/5 - 2904620

Technical data

Dimensions

Depth	125 mm
Width with alternative assembly	122 mm
Height with alternative assembly	130 mm
Depth with alternative assembly	39 mm
Installation distance right/left	5 mm / 5 mm
Installation distance top/bottom	50 mm / 50 mm

Ambient conditions

Degree of protection	IP20
Inflammability class in acc. with UL 94 (housing / terminal blocks)	V0
Ambient temperature (operation)	-25 °C ... 70 °C (> 60 °C Derating: 2.5 %/K)
Ambient temperature (start-up type tested)	-40 °C
Ambient temperature (storage/transport)	-40 °C ... 85 °C
Max. permissible relative humidity (operation)	≤ 95 % (at 25 °C, non-condensing)
Climatic class	3K3 (in acc. with EN 60721)
Degree of pollution	2
Installation height	≤ 5000 m (> 2000 m, observe derating)

Input data

Nominal input voltage	3 V
	3 V
Nominal input voltage range	3x 400 V AC ... 500 V AC
	2x 400 V AC ... 500 V AC
	± 300 V DC
Input voltage range	3x 400 V AC ... 500 V AC -20 % ... +10 %
	2x 400 V AC ... 500 V AC -10 % ... +10 %
	± 260 V DC ... 300 V DC -25 % ... +30 %
AC frequency range	50 Hz ... 60 Hz -10 % ... +10 %
Frequency range (f _N)	50 Hz ... 60 Hz -10 % ... +10 %
Discharge current to PE	< 3.5 mA
Current consumption	3x 0.53 A (400 V AC)
	3x 0.44 A (480 V AC)
	2x 0.9 A (400 V AC)
	2x 0.66 A (480 V AC)
	3x 0.45 A (500 V AC)
	2x 0.8 A (500 V AC)
Nominal power consumption	283 VA
Inrush current	typ. 11 A (at 25 °C)
Mains buffering time	typ. 34 ms (3x 400 V AC)
	typ. 50 ms (3x 480 V AC)
Input fuse	2 A (slow-blow, internal)
Recommended breaker for input protection	3x 6 A (Characteristic B, C or comparable)

Power supply unit - QUINT4-PS/3AC/24DC/5 - 2904620

Technical data

Input data

Power factor (cos phi)	0.48
Type of protection	Transient surge protection
Protective circuit/component	Varistor, gas-filled surge arrester

Output data

Nominal output voltage	24 V DC
Setting range of the output voltage (U_{Set})	24 V DC ... 29.5 V DC (constant capacity)
Nominal output current (I_N)	5 A
Static Boost ($I_{Stat.Boost}$)	6.25 A
Dynamic Boost ($I_{Dyn.Boost}$)	10 A (5 s)
Selective Fuse Breaking (I_{SFB})	30 A (15 ms)
Derating	> 60 °C ... 70 °C (2.5%/K)
Connection in parallel	Yes, for redundancy and increased capacity
Connection in series	yes
Feedback voltage resistance	≤ 35 V DC
Protection against overvoltage at the output (OVP)	≤ 32 V DC
Control deviation	< 0.5 % (Static load change 10 % ... 90 %)
	< 2 % (Dynamic load change 10 % ... 90 %, (10 Hz))
	< 0.25 % (change in input voltage ±10 %)
Residual ripple	< 30 mV _{PP} (with nominal values)
Output power	120 W
Typical response time	300 ms (from SLEEP MODE)
Maximum power dissipation in no-load condition	< 3 W (400 V AC)
	< 4 W (480 V AC)
Power loss nominal load max.	< 15 W (400 V AC)
	< 17 W (480 V AC)

General

Net weight	0.6 kg
Environmental protection directive	RoHS Directive 2011/65/EU
	WEEE
	Reach
Efficiency	typ. 89 % (400 V AC)
	typ. 87.5 % (480 V AC)
MTBF (IEC 61709, SN 29500)	> 1560000 h (25 °C)
	> 914000 h (40 °C)
	> 413000 h (60 °C)
Insulation voltage input/output	4 kV AC (type test)
	2.4 kV AC (routine test)
Insulation voltage input / PE	3.5 kV AC (type test)
	2.4 kV AC (routine test)

Power supply unit - QUINT4-PS/3AC/24DC/5 - 2904620

Technical data

General

Insulation voltage output / PE	0.5 kV DC (type test)
	0.5 kV DC (routine test)
Degree of protection	IP20
Protection class	I
Inflammability class in acc. with UL 94 (housing / terminal blocks)	V0
Mounting position	horizontal DIN rail NS 35, EN 60715
Assembly instructions	alignable: $P_N \geq 50\%$, 5 mm horizontally, 15 mm next to active components, 50 mm vertically alignable: $P_N < 50\%$, 0 mm horizontally, 40 mm vertically top, 20 mm vertically bottom

Connection data, input

Connection method	Screw connection
Conductor cross section solid min.	0.2 mm ²
Conductor cross section solid max.	6 mm ²
Conductor cross section flexible min.	0.2 mm ²
Conductor cross section flexible max.	4 mm ²
Conductor cross section AWG min.	24
Conductor cross section AWG max.	10
Stripping length	8 mm

Connection data, output

Connection method	Screw connection
Conductor cross section solid min.	0.2 mm ²
Conductor cross section solid max.	2.5 mm ²
Conductor cross section flexible min.	0.2 mm ²
Conductor cross section flexible max.	2.5 mm ²
Conductor cross section AWG min.	24
Conductor cross section AWG max.	14
Stripping length	6.5 mm

Connection data for signaling

Connection method	Push-in connection
Conductor cross section solid min.	0.2 mm ²
Conductor cross section solid max.	1 mm ²
Conductor cross section flexible min.	0.2 mm ²
Conductor cross section flexible max.	1.5 mm ²
Conductor cross section AWG min.	24
Conductor cross section AWG max.	16
Stripping length	8 mm

Standards

EMC requirements for noise immunity	EN 61000-6-1
	EN 61000-6-2

Power supply unit - QUINT4-PS/3AC/24DC/5 - 2904620

Technical data

Standards

EMC requirements for noise emission	EN 61000-6-3
	EN 61000-6-4
EMC requirements, power plant	IEC 61850-3
	EN 61000-6-5
HART FSK Physical Layer Test Specification Compliance	Output voltage U_{Out} compliant
Standard - Safety of transformers	EN 61558-2-16 (air clearances and creepage distances only)
Standard - Electrical safety	IEC 60950-1/VDE 0805 (SELV)
Standard - safety for equipment for measurement, control, and laboratory use	IEC 61010-1
Standard – Safety extra-low voltage	IEC 60950-1 (SELV)
	EN 60204-1 (PELV)
Standard - power supply devices for low voltage with DC output	EN 61204-3
Standard – Limitation of mains harmonic currents	EN 61000-3-2
Mains variation/undervoltage	SEMI F47-0706, EN 61000-4-11
Rail applications	EN 50121-3-2
	EN 50121-4
	EN 50121-5
	IEC 62236-3-2
	IEC 62236-4
	IEC 62236-5

Conformance/approvals

UL approvals	UL Listed UL 508
	UL/C-UL Recognized UL 60950-1
	UL ANSI/ISA-12.12.01 Class I, Division 2, Groups A, B, C, D (Hazardous Location)
CSA	CAN/CSA-C22.2 No. 60950-1-07
	CSA-C22.2 No. 107.1-01
SIQ	BG (type approved)
Shipbuilding approval	DNV GL, PRS, BV, LR, ABS

EMC data

Electromagnetic compatibility	Conformance with EMC Directive 2014/30/EU
Low Voltage Directive	Conformance with Low Voltage Directive 2014/35/EC
Conducted noise emission	EN 55016
	EN 61000-6-3 (Class B)
Noise emission	EN 55016
	EN 61000-6-3 (Class B)
Harmonic currents	EN 61000-3-2
	EN 61000-3-2 (Class A)
Flicker	EN 61000-3-3
	EN 61000-3-3

Power supply unit - QUINT4-PS/3AC/24DC/5 - 2904620

Technical data

EMC data

DNV GL conducted interference	Class A
Additional text	Area power distribution
DNV GL noise radiation	Class B
Additional text	Bridge and deck area
Electrostatic discharge	EN 61000-4-2
Contact discharge	8 kV (Test Level 4)
Discharge in air	15 kV (Test Level 4)
Electromagnetic HF field	EN 61000-4-3
Frequency range	80 MHz ... 1 GHz
Test field strength	20 V/m (Test Level 3)
Frequency range	1 GHz ... 6 GHz
Test field strength	10 V/m (Test Level 3)
Frequency range	1 GHz ... 6 GHz
Test field strength	10 V/m (Test Level 3)
Comments	Criterion A
Fast transients (burst)	EN 61000-4-4
Input	4 kV (Test Level 4 - asymmetrical)
Output	4 kV (Test Level 4 - asymmetrical)
Signal	2 kV (Test Level 4 - asymmetrical)
Comments	Criterion B
Surge voltage load (surge)	EN 61000-4-5
Input	3 kV (Test Level 4 - symmetrical)
	6 kV (Test Level 4 - asymmetrical)
Output	1 kV (Test Level 3 - symmetrical)
	2 kV (Test Level 3 - asymmetrical)
Signal	1 kV (Test Level 2 - asymmetrical)
Comments	Criterion A
Conducted interference	EN 61000-4-6
I/O/S	asymmetrical
Frequency range	0.15 MHz ... 80 MHz
Voltage	10 V (Test Level 3)
Comments	Criterion A
Power frequency magnetic field	EN 61000-4-8
Frequency	16.7 Hz
	50 Hz
	60 Hz
Test field strength	100 A/m
Additional text	60 s
Comments	Criterion A
Frequency	50 Hz

Power supply unit - QUINT4-PS/3AC/24DC/5 - 2904620

Technical data

EMC data

	60 Hz
Frequency range	50 Hz ... 60 Hz
Test field strength	1 kA/m
Additional text	3 s
Frequency	0 Hz
Test field strength	300 A/m
Additional text	DC, 60 s
Voltage dips	EN 61000-4-11
Voltage	400 V AC
Frequency	50 Hz
Voltage dip	70 %
Number of periods	0.5 / 1 / 25 periods
Additional text	Test Level 2
Comments	Criterion A: 0.5 / 1 period Criterion B: 25 periods
Voltage dip	40 %
Number of periods	5 / 10 / 50 periods
Additional text	Test Level 2
Comments	Criterion B
Voltage dip	0 %
Number of periods	0,5 / 1 / 5 / 50 / 250 periods
Additional text	Test Level 2
Comments	Criterion A: 0.5 / 1 period Criterion B: 5 / 50 / 250 periods
Pulse-shape magnetic field	EN 61000-4-9
Test field strength	1000 A/m
Comments	Criterion A
Damped oscillating magnetic field	EN 61000-4-10
Test field strength	110 A/m
Test level 1	100 kHz
Test field strength	110 A/m
Test level 2	1 MHz
Comments	Criterion A
Attenuated sinusoidal oscillations (ring wave)	EN 61000-4-12
Input	3 kV (Test Level 4 - symmetrical) 6 kV (Test Level 4 - asymmetrical)
Comments	Criterion A
Asymmetrical conducted disturbance variables	EN 61000-4-16
Test level 1	15 Hz 150 Hz (Test Level 4)
Voltage	30 V 3 V
Test level 2	150 Hz 1.5 kHz (Test Level 4)

Power supply unit - QUINT4-PS/3AC/24DC/5 - 2904620

Technical data

EMC data

Voltage	3 V
Test level 3	1.5 kHz 15 kHz (Test Level 4)
Voltage	3 V 30 V
Test level 4	15 kHz 150 kHz (Test Level 4)
Voltage	30 V
Test level 5	16.7 Hz 50 Hz 60 Hz (Test Level 4)
Voltage	30 V (Permanent)
Test level 6	16.7 Hz 50 Hz 60 Hz (Test Level 4)
Voltage	300 V (1 s)
Comments	Criterion A
Attenuated oscillating wave	EN 61000-4-18
Input, output (test level 1)	100 kHz 1 MHz (Test Level 3 - symmetrical)
Voltage	1 kV
Input, output (test level 2)	10 MHz
Voltage	1 kV
Input, output (test level 3)	100 kHz 1 MHz (Test Level 3 - asymmetrical)
Voltage	2.5 kV
Signals (test level 1)	100 kHz 1 MHz (Test Level 3 - symmetrical)
Voltage	1 kV
Signals (test level 2)	100 kHz 1 MHz (Test Level 3 - asymmetrical)
Voltage	2.5 kV
Comments	Criterion A
Criterion A	Normal operating behavior within the specified limits.
Criterion B	Temporary impairment to operational behavior that is corrected by the device itself.
Criterion C	Temporary adverse effects on the operating behavior, which the device corrects automatically or which can be restored by actuating the operating elements.

Environmental Product Compliance

REACH SVHC	Lead 7439-92-1
China RoHS	Environmentally Friendly Use Period = 25;
	For details about hazardous substances go to tab "Downloads", Category "Manufacturer's declaration"

Drawings

Power supply unit - QUINT4-PS/3AC/24DC/5 - 2904620

Block diagram

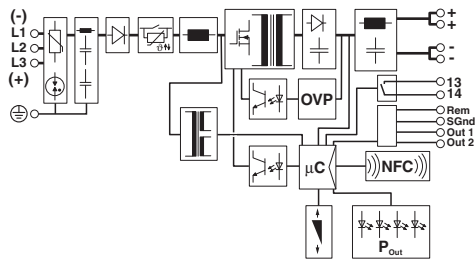

Diagram

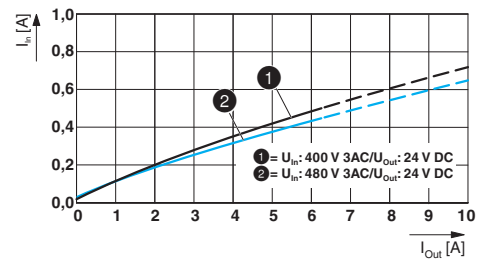

Diagram

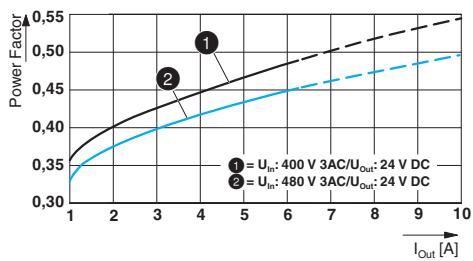

Diagram

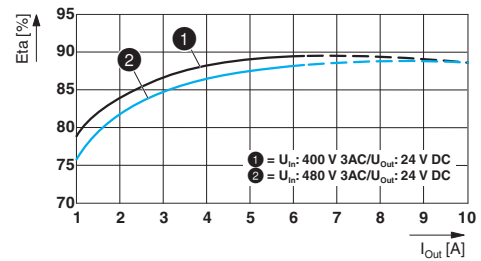

Diagram

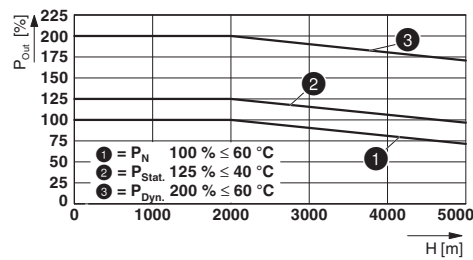

Dimensional drawing

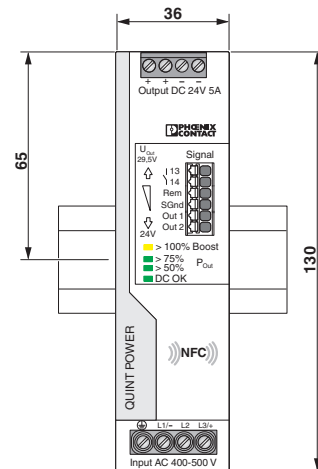

Power supply unit - QUINT4-PS/3AC/24DC/5 - 2904620

Dimensional drawing

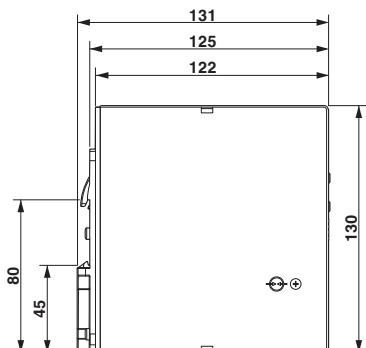

Schematic diagram

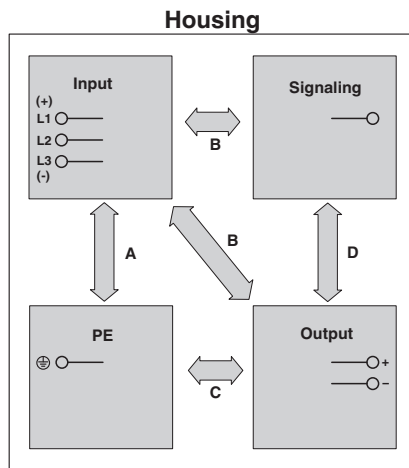

Pictogram



Classifications

eCl@ss

eCl@ss 10.0.1	27040701
eCl@ss 11.0	27040701
eCl@ss 5.1	27242213
eCl@ss 6.0	27049005
eCl@ss 9.0	27040701

ETIM

ETIM 6.0	EC002540
----------	----------

Power supply unit - QUINT4-PS/3AC/24DC/5 - 2904620

Classifications

UNSPSC

UNSPSC 13.2	39121004
UNSPSC 18.0	39121004
UNSPSC 19.0	39121004
UNSPSC 20.0	39121004
UNSPSC 21.0	39121004

Approvals

Approvals

Approvals

DNV GL / Type approved / CSA / PRS / BV / LR / ABS / UL Listed / UL Recognized / cUL Recognized / IECCEB Scheme / cUL Listed / CSAus / EAC / cULus Recognized / cULus Listed / cCSAus

Ex Approvals











UL Listed / cUL Listed / cULus Listed

Approval details

DNV GL		https://approvalfinder.dnvgl.com/	TAA00000BV
Type approved			SI-SIQ BG 005/023
CSA		http://www.csagroup.org/services-industries/product-listing/	70066458
PRS		http://www.prs.pl/	TE/2104/880590/16
BV		http://www.veristar.com/portal/veristarinfo/generalinfo/approved/approvedProducts/equipmentAndMaterials	44621/A0 BV

Power supply unit - QUINT4-PS/3AC/24DC/5 - 2904620

Approvals

LR		http://www.lr.org/en	17-20107-02
ABS		http://www.eagle.org/eagleExternalPortalWEB/	20-1973616-PDA
UL Listed		http://database.ul.com/cgi-bin/XYV/template/LISEXT/1FRAME/index.htm	FILE E 123528
UL Recognized		http://database.ul.com/cgi-bin/XYV/template/LISEXT/1FRAME/index.htm	FILE E 211944
cUL Recognized		http://database.ul.com/cgi-bin/XYV/template/LISEXT/1FRAME/index.htm	FILE E 211944
IECEE CB Scheme		http://www.iecee.org/	SI-5291
cUL Listed		http://database.ul.com/cgi-bin/XYV/template/LISEXT/1FRAME/index.htm	FILE E 123528
CSAus		http://www.csagroup.org/services-industries/product-listing/	70066458
EAC			RU*DE*08.B.01873/19
cULus Recognized			
cULus Listed			

Power supply unit - QUINT4-PS/3AC/24DC/5 - 2904620

Approvals

cCSAus



Accessories

Accessories

Assembly adapter

Assembly adapters - UWA 182/52 - 2938235



Universal wall adapter for securely mounting the device in the event of strong vibrations. The device is screwed directly onto the mounting surface. The universal wall adapter is attached on the top/bottom.

Assembly adapters - UWA 130 - 2901664



2-piece universal wall adapter for securely mounting the device in the event of strong vibrations. The profiles that are screwed onto the side of the device are screwed directly onto the mounting surface. The universal wall adapter is attached on the left/right.

Assembly adapters - QUINT-PS-ADAPTERS7/1 - 2938196



Assembly adapter for QUINT-PS... power supply on S7-300 rail

Device circuit breakers

Electronic circuit breaker - CBMC E4 24DC/1-4A NO - 2906031



Multi-channel electronic circuit breaker for protecting four loads at 24 V DC in the event of overload and short circuit. With electronic locking of the set nominal currents. For installation on DIN rails.

Power supply unit - QUINT4-PS/3AC/24DC/5 - 2904620

Accessories

Electronic circuit breaker - CBMC E4 24DC/1-4A+ IOL - 2910410



Multi-channel electronic circuit breaker with IO-Link interface for protecting four loads at 24 V DC in the event of overload and short circuit. With electronic locking of the set nominal currents. For installation on DIN rails.

Device protection

Type 3 surge protection device - PLT-SEC-T3-3S-230-FM - 2905230



Plug-in device protection, according to type 3/class III, for 3-phase power supply networks with separate N and PE (5-conductor system: L1, L2, L3, N, PE), with integrated surge-proof fuse and remote indication contact.

Type 3 surge protection device - PLT-SEC-T3-24-FM-UT - 2907916



Type 3 surge protection, consisting of protective plug and base element, with integrated status indicator and remote signaling for single-phase power supply networks. Nominal voltage: 24 V AC/DC

Type 3 surge protection device - PLT-SEC-T3-24-FM-PT - 2907925



Type 3 surge protection, consisting of protective plug and base element, with integrated status indicator and remote signaling for single-phase power supply networks. Nominal voltage: 24 V AC/DC

Fuse

Fuse - FUSE 10,3X38 6A PV A - 3062778



Fuse, for the photovoltaics industry according to UL 2579, nominal current: 6 A, length: 38 mm, diameter: 10.3 mm, color: white

Programming adapter

Power supply unit - QUINT4-PS/3AC/24DC/5 - 2904620

Accessories

Programming adapter - TWN4 MIFARE NFC USB ADAPTER - 2909681



Near Field Communication (NFC) programming adapter with USB interface for the wireless configuration of NFC-capable products from PHOENIX CONTACT with software. No separate USB driver is required.

Phoenix Contact 2021 © - all rights reserved
<http://www.phoenixcontact.com>