

# Power supply unit - QUINT4-PS/1AC/24DC/20 - 2904602

Please be informed that the data shown in this PDF Document is generated from our Online Catalog. Please find the complete data in the user's documentation. Our General Terms of Use for Downloads are valid (<http://phoenixcontact.com/download>)

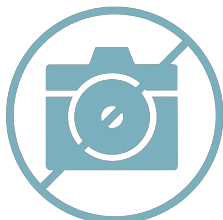

Primary-switched QUINT POWER power supply with free choice of output characteristic curve, SFB (selective fuse breaking) technology, and NFC interface, input: 1-phase, output: 24 V DC/20 A

## Product Description

The fourth generation of the high-performance QUINT POWER power supplies ensures superior system availability by means of new functions. Signaling thresholds and characteristic curves can be individually adjusted via the NFC interface. The unique SFB technology and preventive function monitoring of the QUINT POWER power supply increase the availability of your application.

## Your advantages

- SFB technology trips standard circuit breakers selectively, loads that are connected in parallel continue working
- Preventive function monitoring indicates critical operating states before errors occur
- Signaling thresholds and characteristic curves that can be adjusted via NFC maximize system availability
- Easy system extension thanks to static boost; starting of difficult loads thanks to dynamic boost
- High degree of immunity, thanks to integrated gas-filled surge arrester and mains failure bridging time of more than 20 milliseconds
- Robust design thanks to metal housing and wide temperature range from -40°C to +70°C
- Worldwide use thanks to the wide range input and international approval package



## Key Commercial Data

Packing unit	1 pc
GTIN	 4 046356 985352
GTIN	4046356985352
Weight per Piece (excluding packing)	1,593.000 g
Weight per piece (including packing)	1,640.500 g
Custom tariff number	85044030
Country of origin	Thailand

## Technical data

### Dimensions

Width	70 mm
Height	130 mm

# Power supply unit - QUINT4-PS/1AC/24DC/20 - 2904602

## Technical data

### Dimensions

Depth	125 mm
Width with alternative assembly	122 mm
Height with alternative assembly	130 mm
Depth with alternative assembly	73 mm
Installation distance right/left	5 mm / 5 mm
Installation distance top/bottom	50 mm / 50 mm

### Ambient conditions

Degree of protection	IP20
Inflammability class in acc. with UL 94 (housing / terminal blocks)	V0
Ambient temperature (operation)	-25 °C ... 70 °C (> 60 °C Derating: 2.5 %/K)
Ambient temperature (start-up type tested)	-40 °C
Ambient temperature (storage/transport)	-40 °C ... 85 °C
Max. permissible relative humidity (operation)	≤ 95 % (at 25 °C, non-condensing)
Climatic class	3K3 (in acc. with EN 60721)
Degree of pollution	2
Installation height	≤ 5000 m (> 2000 m, observe derating)

### Input data

Nominal input voltage range	100 V AC ... 240 V AC
	110 V DC ... 250 V DC
Input voltage range	100 V AC ... 240 V AC -15 % ... +10 %
	110 V DC ... 250 V DC -18 % ... +40 %
Dielectric strength maximum	300 V AC 60 s
AC frequency range	50 Hz ... 60 Hz -10 % ... +10 %
Frequency range (f <sub>N</sub> )	50 Hz ... 60 Hz -10 % ... +10 %
	16.7 Hz (acc. to EN 50163)
Discharge current to PE	< 3.5 mA
Current consumption	6.8 A (100 V AC)
	5.5 A (120 V AC)
	2.8 A (230 V AC)
	2.7 A (240 V AC)
Nominal power consumption	520 VA
Inrush current	typ. 11 A (at 25 °C)
Mains buffering time	typ. 28 ms (120 V AC)
	typ. 29 ms (230 V AC)
Input fuse	12 A (slow-blow, internal)
Recommended breaker for input protection	10 A ... 16 A (Characteristic B, C, D, K or comparable)
Power factor (cos phi)	0.98
Type of protection	Transient surge protection
Protective circuit/component	Varistor, gas-filled surge arrester

# Power supply unit - QUINT4-PS/1AC/24DC/20 - 2904602

## Technical data

### Output data

Nominal output voltage	24 V DC
Setting range of the output voltage ( $U_{Set}$ )	24 V DC ... 29.5 V DC (constant capacity)
Nominal output current ( $I_N$ )	20 A
Static Boost ( $I_{Stat.Boost}$ )	25 A
Dynamic Boost ( $I_{Dyn.Boost}$ )	30 A (5 s)
Selective Fuse Breaking ( $I_{SFB}$ )	120 A (15 ms)
Derating	> 60 °C ... 70 °C (2.5%/K)
Connection in parallel	Yes, for redundancy and increased capacity
Connection in series	yes
Feedback voltage resistance	≤ 35 V DC
Protection against overvoltage at the output (OVP)	≤ 32 V DC
Control deviation	< 0.5 % (Static load change 10 % ... 90 %)
	< 4 % (Dynamic load change 10 % ... 90 %, (10 Hz))
	< 0.25 % (change in input voltage ±10 %)
Residual ripple	< 50 mV <sub>PP</sub> (with nominal values)
Output power	480 W
Typical response time	300 ms (from SLEEP MODE)
Maximum power dissipation in no-load condition	< 5 W (120 V AC)
	< 5 W (230 V AC)
Power loss nominal load max.	< 40 W (120 V AC)
	< 32 W (230 V AC)

### General

Net weight	1.3 kg
Environmental protection directive	RoHS Directive 2011/65/EU
	WEEE
	Reach
Efficiency	typ. 92.4 % (120 V AC)
	typ. 94 % (230 V AC)
MTBF (IEC 61709, SN 29500)	> 1112000 h (25 °C)
	> 673000 h (40 °C)
	> 309000 h (60 °C)
Insulation voltage input/output	4 kV AC (type test)
	2 kV AC (routine test)
Insulation voltage input / PE	2.5 kV AC (type test)
	2.4 kV AC (routine test)
Insulation voltage output / PE	0.5 kV DC (type test)
	0.5 kV DC (routine test)
Degree of protection	IP20
Protection class	I
Inflammability class in acc. with UL 94 (housing / terminal blocks)	V0

# Power supply unit - QUINT4-PS/1AC/24DC/20 - 2904602

## Technical data

### General

Mounting position	horizontal DIN rail NS 35, EN 60715
Assembly instructions	alignable: $P_N \geq 50\%$ , 5 mm horizontally, 15 mm next to active components, 50 mm vertically alignable: $P_N < 50\%$ , 0 mm horizontally, 40 mm vertically top, 20 mm vertically bottom

### Connection data, input

Connection method	Screw connection
Conductor cross section solid min.	0.2 mm <sup>2</sup>
Conductor cross section solid max.	6 mm <sup>2</sup>
Conductor cross section flexible min.	0.2 mm <sup>2</sup>
Conductor cross section flexible max.	4 mm <sup>2</sup>
Conductor cross section AWG min.	24
Conductor cross section AWG max.	10
Stripping length	8 mm

### Connection data, output

Connection method	Screw connection
Conductor cross section solid min.	0.2 mm <sup>2</sup>
Conductor cross section solid max.	6 mm <sup>2</sup>
Conductor cross section flexible min.	0.2 mm <sup>2</sup>
Conductor cross section flexible max.	4 mm <sup>2</sup>
Conductor cross section AWG min.	24
Conductor cross section AWG max.	10
Stripping length	8 mm

### Connection data for signaling

Connection method	Push-in connection
Conductor cross section solid min.	0.2 mm <sup>2</sup>
Conductor cross section solid max.	1 mm <sup>2</sup>
Conductor cross section flexible min.	0.2 mm <sup>2</sup>
Conductor cross section flexible max.	1.5 mm <sup>2</sup>
Conductor cross section AWG min.	24
Conductor cross section AWG max.	16
Stripping length	8 mm

### Standards

EMC requirements for noise immunity	EN 61000-6-1
	EN 61000-6-2
EMC requirements for noise emission	EN 61000-6-3
	EN 61000-6-4
EMC requirements, power plant	IEC 61850-3
	EN 61000-6-5
HART FSK Physical Layer Test Specification Compliance	Output voltage $U_{Out}$ compliant

# Power supply unit - QUINT4-PS/1AC/24DC/20 - 2904602

## Technical data

### Standards

Standard - Safety of transformers	EN 61558-2-16 (air clearances and creepage distances only)
Standard - Electrical safety	IEC 60950-1/VDE 0805 (SELV)
Standard - safety for equipment for measurement, control, and laboratory use	IEC 61010-1
Standard – Safety extra-low voltage	IEC 60950-1 (SELV)
	EN 60204-1 (PELV)
Standard - power supply devices for low voltage with DC output	EN 61204-3
Standard – Limitation of mains harmonic currents	EN 61000-3-2
Mains variation/undervoltage	SEMI F47-0706, EN 61000-4-11
Rail applications	EN 50121-3-2
	EN 50121-4
	EN 50121-5
	IEC 62236-3-2
	IEC 62236-4
	IEC 62236-5

### Conformance/approvals

UL approvals	UL Listed UL 508
	UL/C-UL Recognized UL 60950-1
	UL ANSI/ISA-12.12.01 Class I, Division 2, Groups A, B, C, D (Hazardous Location)
CSA	CAN/CSA-C22.2 No. 60950-1-07
	CSA-C22.2 No. 107.1-01
SIQ	BG (type approved)
Shipbuilding approval	DNV GL, PRS, BV, LR, ABS

### EMC data

Electromagnetic compatibility	Conformance with EMC Directive 2014/30/EU
Low Voltage Directive	Conformance with Low Voltage Directive 2014/35/EC
Conducted noise emission	EN 55016
	EN 61000-6-3 (Class B)
Noise emission	EN 55016
	EN 61000-6-3 (Class B)
Harmonic currents	EN 61000-3-2
	EN 61000-3-2 (Class A)
Flicker	EN 61000-3-3
	EN 61000-3-3
DNV GL conducted interference	Class A
Additional text	Area power distribution
DNV GL noise radiation	Class B
Additional text	Bridge and deck area
Electrostatic discharge	EN 61000-4-2

# Power supply unit - QUINT4-PS/1AC/24DC/20 - 2904602

## Technical data

### EMC data

Contact discharge	8 kV (Test Level 4)
Discharge in air	15 kV (Test Level 4)
Electromagnetic HF field	EN 61000-4-3
Frequency range	80 MHz ... 1 GHz
Test field strength	20 V/m (Test Level 3)
Frequency range	1 GHz ... 6 GHz
Test field strength	10 V/m (Test Level 3)
Frequency range	1 GHz ... 6 GHz
Test field strength	10 V/m (Test Level 3)
Comments	Criterion A
Fast transients (burst)	EN 61000-4-4
Input	4 kV (Test Level 4 - asymmetrical)
Output	4 kV (Test Level 4 - asymmetrical)
Signal	4 kV (Test Level 4 - asymmetrical)
Comments	Criterion A
Surge voltage load (surge)	EN 61000-4-5
Input	3 kV (Test Level 4 - symmetrical)
	6 kV (Test Level 4 - asymmetrical)
Output	1 kV (Test Level 3 - symmetrical)
	2 kV (Test Level 3 - asymmetrical)
Signal	4 kV (Test Level 4 - asymmetrical)
Comments	Criterion A
Conducted interference	EN 61000-4-6
I/O/S	asymmetrical
Frequency range	0.15 MHz ... 80 MHz
Voltage	10 V (Test Level 3)
Comments	Criterion A
Power frequency magnetic field	EN 61000-4-8
Frequency	16.7 Hz
	50 Hz
	60 Hz
Test field strength	100 A/m
Additional text	60 s
Comments	Criterion A
Frequency	50 Hz
	60 Hz
Frequency range	50 Hz ... 60 Hz
Test field strength	1 kA/m
Additional text	3 s
Frequency	0 Hz

# Power supply unit - QUINT4-PS/1AC/24DC/20 - 2904602

## Technical data

### EMC data

Test field strength	300 A/m
Additional text	DC, 60 s
Voltage dips	EN 61000-4-11
Voltage	230 V AC
Frequency	50 Hz
Voltage dip	70 %
Number of periods	0.5 / 1 / 25 / 30 periods
Additional text	Test Level 2
Comments	Criterion A: 0.5 / 1 / 25 / 30 periods
Voltage dip	40 %
Number of periods	5 / 10 / 50 periods
Additional text	Test Level 2
Comments	Criterion A
Voltage dip	0 %
Number of periods	0,5 / 1 / 5 / 50 / 250 periods
Additional text	Test Level 2
Comments	Criterion A: 0.5 / 1 period Criterion B: 5 / 50 / 250 periods
Pulse-shape magnetic field	EN 61000-4-9
Test field strength	1000 A/m
Comments	Criterion A
Damped oscillating magnetic field	EN 61000-4-10
Test field strength	110 A/m
Test level 1	100 kHz
Test field strength	110 A/m
Test level 2	1 MHz
Comments	Criterion A
Attenuated sinusoidal oscillations (ring wave)	EN 61000-4-12
Input	2 kV (Test Level 4 - symmetrical) 4 kV (Test Level 4 - asymmetrical)
Comments	Criterion A
Asymmetrical conducted disturbance variables	EN 61000-4-16
Test level 1	15 Hz 150 Hz (Test Level 4)
Voltage	30 V 3 V
Test level 2	150 Hz 1.5 kHz (Test Level 4)
Voltage	3 V
Test level 3	1.5 kHz 15 kHz (Test Level 4)
Voltage	3 V 30 V
Test level 4	15 kHz 150 kHz (Test Level 4)
Voltage	30 V
Test level 5	16.7 Hz 50 Hz 60 Hz (Test Level 4)

# Power supply unit - QUINT4-PS/1AC/24DC/20 - 2904602

## Technical data

### EMC data

Voltage	30 V (Permanent)
Test level 6	150 Hz 180 Hz (Test Level 4)
Voltage	30 V (Permanent)
Test level 7	16.7 Hz 50 Hz 60 Hz (Test Level 4)
Voltage	300 V (1 s)
Comments	Criterion A
Attenuated oscillating wave	EN 61000-4-18
Input, output (test level 1)	100 kHz 1 MHz (Test Level 3 - symmetrical)
Voltage	1 kV
Input, output (test level 2)	10 MHz
Voltage	1 kV
Input, output (test level 3)	100 kHz 1 MHz (Test Level 3 - asymmetrical)
Voltage	2.5 kV
Signals (test level 1)	100 kHz 1 MHz (Test Level 3 - symmetrical)
Voltage	1 kV
Signals (test level 2)	100 kHz 1 MHz (Test Level 3 - asymmetrical)
Voltage	2.5 kV
Comments	Criterion A
Criterion A	Normal operating behavior within the specified limits.
Criterion B	Temporary impairment to operational behavior that is corrected by the device itself.
Criterion C	Temporary adverse effects on the operating behavior, which the device corrects automatically or which can be restored by actuating the operating elements.

### Environmental Product Compliance

REACH SVHC	Lead 7439-92-1
China RoHS	Environmentally Friendly Use Period = 25;
	For details about hazardous substances go to tab "Downloads", Category "Manufacturer's declaration"

## Drawings

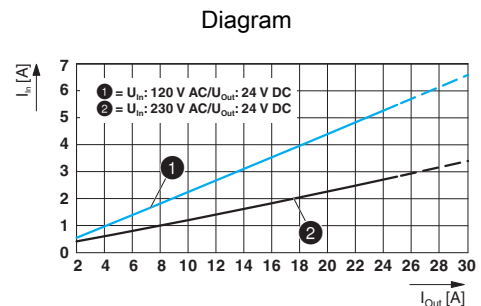
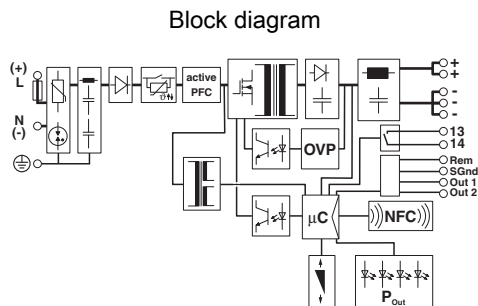



# Power supply unit - QUINT4-PS/1AC/24DC/20 - 2904602

Diagram

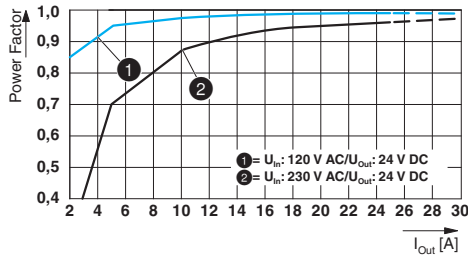

Diagram

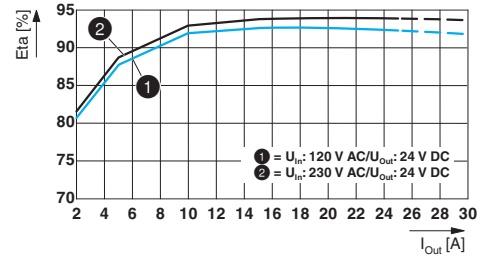

Diagram

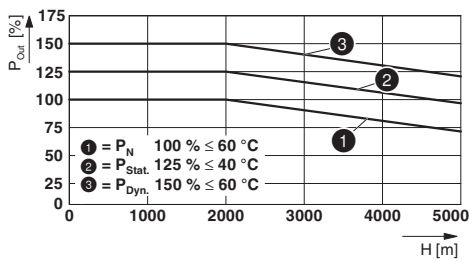

Dimensional drawing

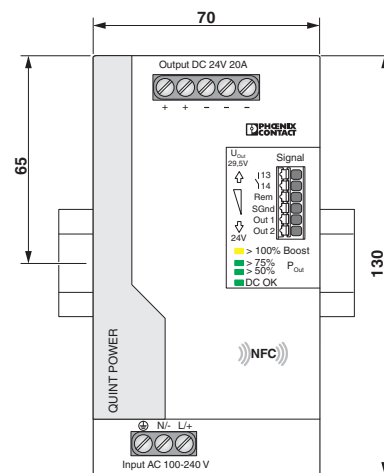

Dimensional drawing

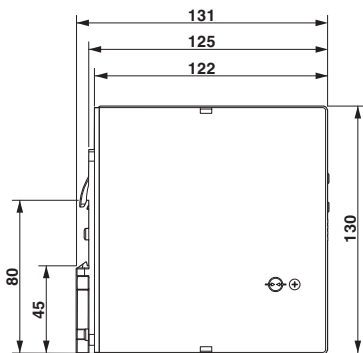

Schematic diagram

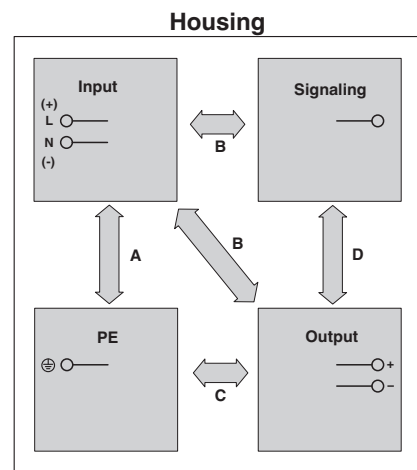

# Power supply unit - QUINT4-PS/1AC/24DC/20 - 2904602

Pictogram



## Classifications

### eCl@ss

eCl@ss 10.0.1	27040701
eCl@ss 11.0	27040701
eCl@ss 5.1	27242213
eCl@ss 6.0	27049005
eCl@ss 7.0	27049002
eCl@ss 9.0	27040701

### ETIM

ETIM 6.0	EC002540
----------	----------

### UNSPSC

UNSPSC 13.2	39121004
UNSPSC 18.0	39121004
UNSPSC 19.0	39121004
UNSPSC 20.0	39121004
UNSPSC 21.0	39121004

## Approvals

### Approvals

---

### Approvals

DNV GL / Type approved / CSA / PRS / BV / LR / ABS / UL Listed / UL Recognized / cUL Recognized / IEC CB Scheme / cUL Listed / CSAus / EAC / cULus Recognized / cULus Listed

# Power supply unit - QUINT4-PS/1AC/24DC/20 - 2904602

## Approvals

Ex Approvals

UL Listed / cUL Listed / cULus Listed

### Approval details

DNV GL		<a href="https://approvalfinder.dnvgl.com/">https://approvalfinder.dnvgl.com/</a>	TAA00000BV
Type approved			SI-SIQ BG 005/024
CSA		<a href="http://www.csagroup.org/services-industries/product-listing/">http://www.csagroup.org/services-industries/product-listing/</a>	70070772
PRS		<a href="http://www.prs.pl/">http://www.prs.pl/</a>	TE/2104/880590/16
BV		<a href="http://www.veristar.com/portal/veristarinfo/generalinfo/approved/approvedProducts/equipmentAndMaterials">http://www.veristar.com/portal/veristarinfo/generalinfo/approved/approvedProducts/equipmentAndMaterials</a>	44621/A0 BV
LR		<a href="http://www.lr.org/en">http://www.lr.org/en</a>	17-20107-02
ABS		<a href="http://www.eagle.org/eagleExternalPortalWEB/">http://www.eagle.org/eagleExternalPortalWEB/</a>	20-1973616-PDA
UL Listed		<a href="http://database.ul.com/cgi-bin/XYV/template/LISEXT/1FRAME/index.htm">http://database.ul.com/cgi-bin/XYV/template/LISEXT/1FRAME/index.htm</a>	FILE E 123528
UL Recognized		<a href="http://database.ul.com/cgi-bin/XYV/template/LISEXT/1FRAME/index.htm">http://database.ul.com/cgi-bin/XYV/template/LISEXT/1FRAME/index.htm</a>	FILE E 211944
cUL Recognized		<a href="http://database.ul.com/cgi-bin/XYV/template/LISEXT/1FRAME/index.htm">http://database.ul.com/cgi-bin/XYV/template/LISEXT/1FRAME/index.htm</a>	FILE E 211944

# Power supply unit - QUINT4-PS/1AC/24DC/20 - 2904602

## Approvals

IECEE CB Scheme		<a href="http://www.iecee.org/">http://www.iecee.org/</a>	SI-5328
-----------------	--	---	---------

cUL Listed		<a href="http://database.ul.com/cgi-bin/XYV/template/LISEXT/1FRAME/index.htm">http://database.ul.com/cgi-bin/XYV/template/LISEXT/1FRAME/index.htm</a>	FILE E 123528
------------	--	---	---------------

CSAus		<a href="http://www.csagroup.org/services-industries/product-listing/">http://www.csagroup.org/services-industries/product-listing/</a>	70070772
-------	--	---	----------

EAC			RU*DE*08.B.01873/19
-----	--	--	---------------------

cULus Recognized			
------------------	--	--	--

cULus Listed			
--------------	--	--	--

## Accessories

### Accessories

#### Assembly adapter

##### Assembly adapters - UWA 182/52 - 2938235



Universal wall adapter for securely mounting the device in the event of strong vibrations. The device is screwed directly onto the mounting surface. The universal wall adapter is attached on the top/bottom.

##### Assembly adapters - UWA 130 - 2901664



2-piece universal wall adapter for securely mounting the device in the event of strong vibrations. The profiles that are screwed onto the side of the device are screwed directly onto the mounting surface. The universal wall adapter is attached on the left/right.

## Power supply unit - QUINT4-PS/1AC/24DC/20 - 2904602

### Accessories

Assembly adapters - QUINT-PS-ADAPTERS7/1 - 2938196



Assembly adapter for QUINT-PS... power supply on S7-300 rail

---

### Device circuit breakers

Electronic circuit breaker - CBMC E4 24DC/1-4A NO - 2906031



Multi-channel electronic circuit breaker for protecting four loads at 24 V DC in the event of overload and short circuit. With electronic locking of the set nominal currents. For installation on DIN rails.

---

Electronic circuit breaker - CBMC E4 24DC/1-10A NO - 2906032



Multi-channel electronic circuit breaker for protecting four loads at 24 V DC in the event of overload and short circuit. With electronic locking of the set nominal currents. For installation on DIN rails.

---

Electronic circuit breaker - CBMC E4 24DC/1-4A+ IOL - 2910410



Multi-channel electronic circuit breaker with IO-Link interface for protecting four loads at 24 V DC in the event of overload and short circuit. With electronic locking of the set nominal currents. For installation on DIN rails.

---

Electronic circuit breaker - CBMC E4 24DC/1-10A IOL - 2910411



Multi-channel electronic circuit breaker with IO-Link interface for protecting four loads at 24 V DC in the event of overload and short circuit. With electronic locking of the set nominal currents. For installation on DIN rails.

---

## Power supply unit - QUINT4-PS/1AC/24DC/20 - 2904602

### Accessories

Electronic circuit breaker - CBM E4 24DC/0.5-10A NO-R - 2905743



Multi-channel, electronic circuit breaker with active current limitation for protecting four loads at 24 V DC in the event of overload and short circuit. With nominal current assistant and electronic locking of the set nominal currents. For installation on DIN rails.

---

Electronic circuit breaker - CBM E8 24DC/0.5-10A NO-R - 2905744



Multi-channel, electronic circuit breaker with active current limitation for protecting eight loads at 24 V DC in the event of overload and short circuit. With nominal current assistant and electronic locking of the set nominal currents. For installation on DIN rails.

---

### Device protection

Type 3 surge protection device - PLT-SEC-T3-230-FM-UT - 2907919



Type 2/3 surge protection, consisting of protective plug and base element with screw connection. For single-phase power supply network with integrated status indicator and remote signaling. Nominal voltage: 230 V AC/DC

---

Type 3 surge protection device - PLT-SEC-T3-24-FM-UT - 2907916



Type 3 surge protection, consisting of protective plug and base element, with integrated status indicator and remote signaling for single-phase power supply networks. Nominal voltage: 24 V AC/DC

---

Type 3 surge protection device - PLT-SEC-T3-230-FM-PT - 2907928



Type 2/3 surge protection, consisting of protective plug and base element with Push-in connection. For single-phase power supply network with integrated status indicator and remote signaling. Nominal voltage: 230 V AC/DC

---

## Power supply unit - QUINT4-PS/1AC/24DC/20 - 2904602

### Accessories

Type 3 surge protection device - PLT-SEC-T3-24-FM-PT - 2907925



Type 3 surge protection, consisting of protective plug and base element, with integrated status indicator and remote signaling for single-phase power supply networks. Nominal voltage: 24 V AC/DC

---

### Programming adapter

Programming adapter - TWN4 MIFARE NFC USB ADAPTER - 2909681



Near Field Communication (NFC) programming adapter with USB interface for the wireless configuration of NFC-capable products from PHOENIX CONTACT with software. No separate USB driver is required.